

MARINE CASSETTE LAUTEX NJ-600, -500 AND -300

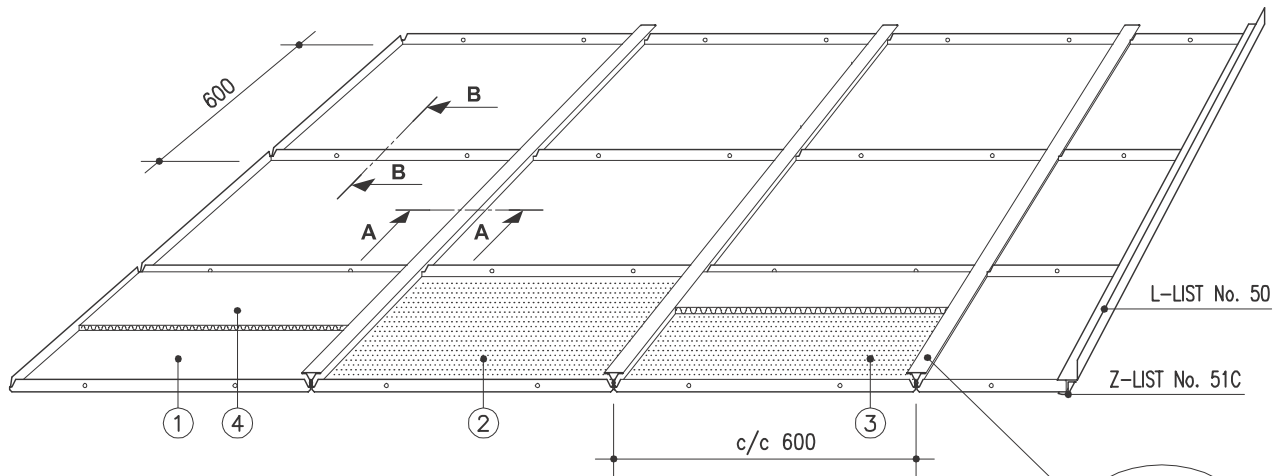

SECTION A - A (ALT. 1)
INSTALLATION WITHOUT AIR SPACE

SECTION B - B (ALT. 1)
INSTALLATION WITHOUT AIR SPACE

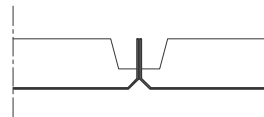
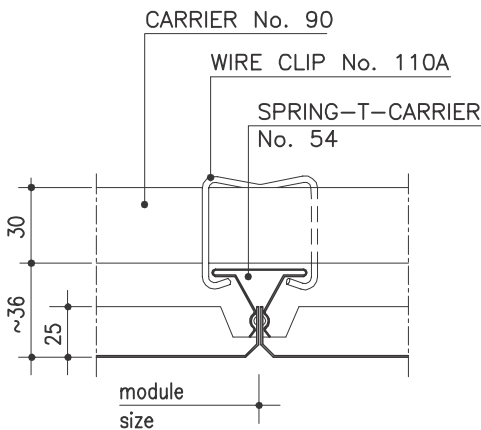

SECTION B - B (ALT. 2)
INSTALLATION WITH AIR SPACE

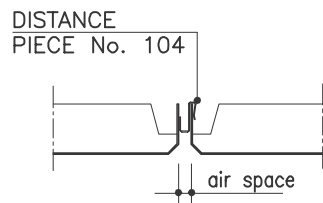

SECTION B - B (ALT. 3)
CASSETTES WITH SHARP EDGES

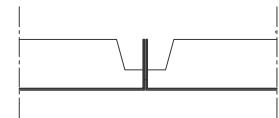

Also with sharp edges; must be specified when order

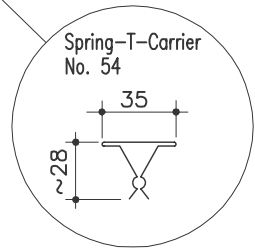

NJ-600 CASSETTES / CLASSIFICATION "C"

Material	0.7 Al, (0.5 Steel)
Module	600x600 mm, 500x500 mm and 300x300 mm
Height	25 mm
Perforation	ø2.0/15% or ø3.5/25%, other alternatives, see group 6 "perforations"
Inlay	mineral wool in plastic or acoustic felt
Finish	stove enamelled (or anodized) according to any well-known colour chart
Ventilation	installation with air space
Protective film	the surface is provided with a protective film if required
Service hatch	see overleaf
Loudspeaker	perforated cassette with ø3.5/25%
Downlight unit	see overleaf
Suspensions	see page 17 & 18 "Suspension systems for J-type cassettes"
Edge lists	see group 6 "Lautex lists" and page 21 "Lautex marine cassettes typical details"
Other special solutions	please contact our technical information department

- ① = NJ-600; unperforated without acoustic inlay
- ② = NJR-600; perforated without acoustic inlay
- ③ = NJRT-600; perforated, with mineral wool in plastic or acoustic felt
- ④ = NJT-600; unperforated, with mineral wool in plastic

Latest information: www.lautex.com

All products are subject to modifications without prior notice

MARINE CASSETTE LAUTEX NJ-600, -500 AND -300 INSTALLATION ACCESSORIES

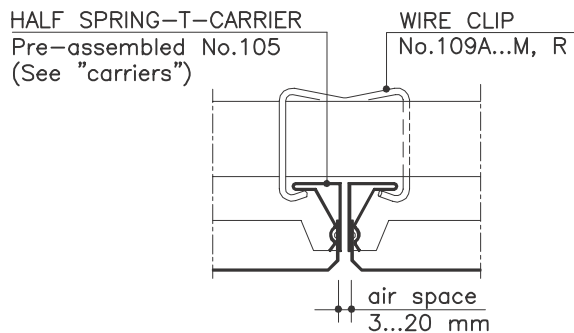
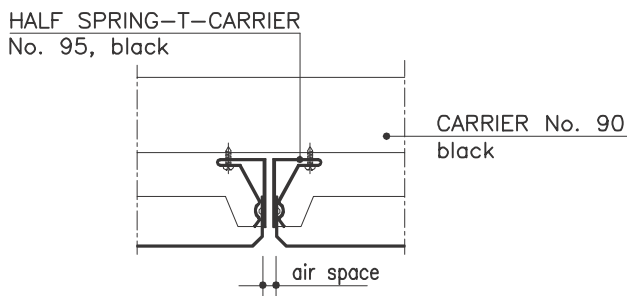
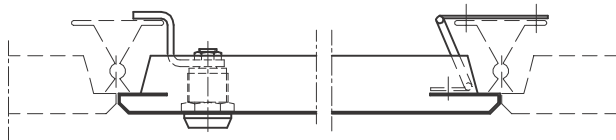
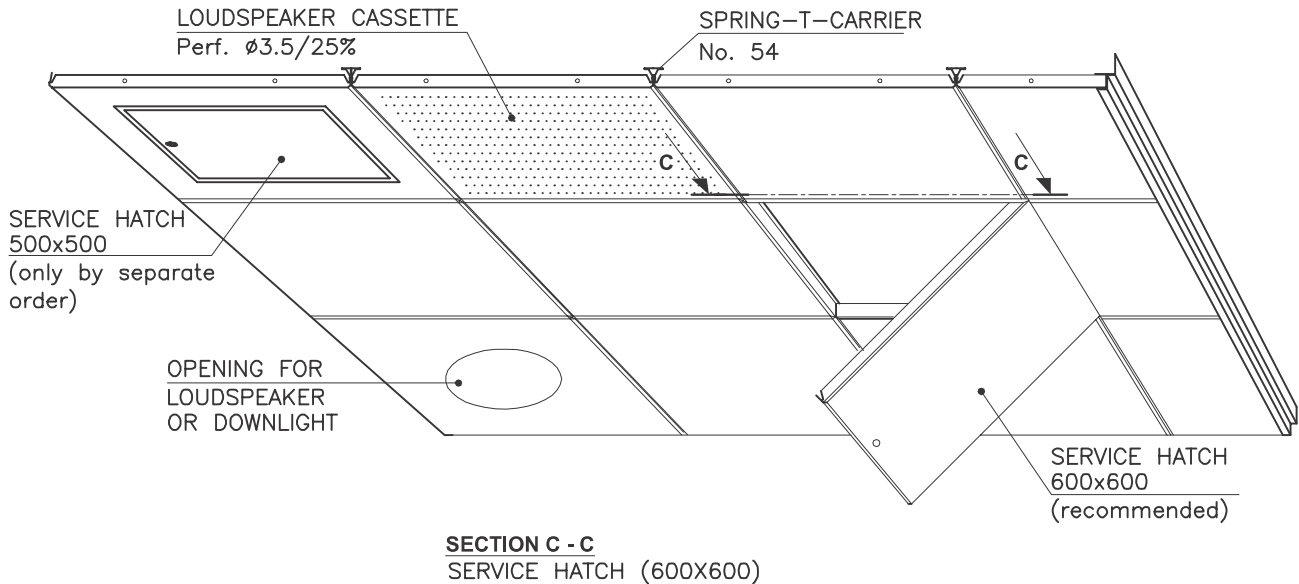

CASSETTE CONNECTION TO WALL PLEASE SEE PAGE 21

THEORETICAL NEED OF SUSPENSION STRUCTURES

Product	Need of material
Carrier No. 90	1.6 m/m ²
Carrier locks	4 pcs/m ²
Z-list No. 51C	0.8 - 1.4 m/m ²
L-list No. 50	0.8 - 1.4 m/m ²
Spring-T-carrier No. 54	1.8 m/m ² NJ-600 2.0 m/m ² NJ-500 4.0 m/m ² NJ-300
Wire clip No. 110	2 pcs/m ² NJ-600
Screw	4 pcs/m ² NJ-600
Wire clip No. 110	2 pcs/m ² NJ-500
Screw	4 pcs/m ² NJ-500
Wire clip No. 110	3 pcs/m ² NJ-300
Screw	6 pcs/m ² NJ-300

WEIGHT OF CEILING

Cassette	NJ-600	NJ-500	NJ-300
Material	0.7 Al	0.7 Al	0.7 Al
Weight	2.1 Kg/m ²	2.2 Kg/m ²	2.6 Kg/m ²

WEIGHT OF OTHER CEILING MATERIALS

Product	Weight of material
Carrier No. 90 (1.0 Steel)	0.83 kg/m
Carrier locks	0.80 g/pcs
Z-list No. 51C (1.0 Al)	0.15 kg/m
L-list No. 50 or 83 (1.5 Al)	0.32 kg/m
L-list No. 50 or 83 (1.0 steel)	0.62 kg/m
Spring-T-carrier (0.5 Steel)	0.44 kg/m
Mineral wool in plastic	0.52 kg/m ²

Latest information: www.lautex.com

All products are subject to modifications without prior notice