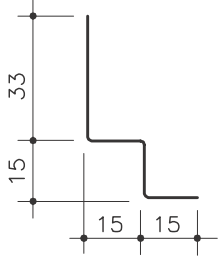
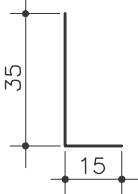
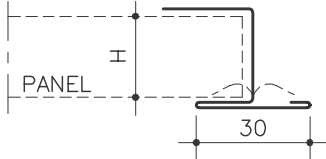
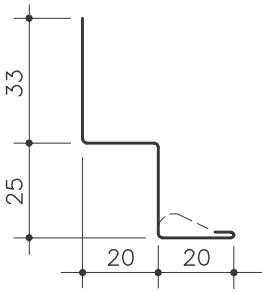
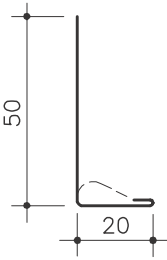
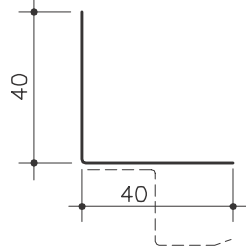
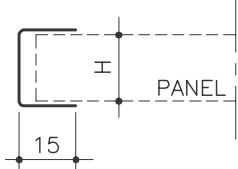
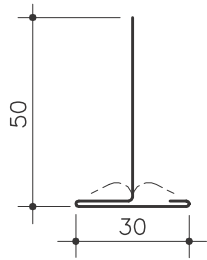

LAUTEX LISTS

Length= 3000

PAGE 1/3

<p>No. 30 DOUBLE-L-LIST</p>  <p>0.7 Al 0.14 kg/m</p>	<p>No. 33 L-LIST</p>  <p>0.7 Al 0.09 kg/m Can be bent</p>	<p>No. 36 PUSH SEAM LIST</p> <table border="1" data-bbox="1117 376 1305 515"> <thead> <tr> <th>No.</th> <th>H</th> </tr> </thead> <tbody> <tr> <td>36A</td> <td>15</td> </tr> <tr> <td>36B</td> <td>20</td> </tr> <tr> <td>36C</td> <td>25</td> </tr> <tr> <td>36C+</td> <td>27</td> </tr> </tbody> </table>  <p>1.0 Al 0.28 kg/m</p>	No.	H	36A	15	36B	20	36C	25	36C+	27																				
No.	H																															
36A	15																															
36B	20																															
36C	25																															
36C+	27																															
<p>No. 31 DOUBLE-L-LIST WITH TONGUE</p>  <p>0.7 Al 0.19 kg/m</p>	<p>No. 34 L-LIST WITH TONGUE</p>  <p>0.7 Al 0.14 kg/m</p>	<p>No. 50 L-LIST 40x40</p>  <p>1.5 Al 0.32 kg/m 1.0 steel 0.62 kg/m</p>																														
<p>No. 32 U-END LIST</p> <table border="1" data-bbox="183 1411 550 1680"> <thead> <tr> <th>No.</th> <th>H</th> <th>Weight kg/m</th> </tr> </thead> <tbody> <tr> <td>32A</td> <td>15</td> <td>0.09</td> </tr> <tr> <td>32B</td> <td>20</td> <td>0.10</td> </tr> <tr> <td>32C</td> <td>25</td> <td>0.10</td> </tr> <tr> <td>32C+</td> <td>27</td> <td>0.10</td> </tr> <tr> <td>32D</td> <td>30</td> <td>0.11</td> </tr> <tr> <td>32E</td> <td>35</td> <td>0.12</td> </tr> <tr> <td>32F</td> <td>40</td> <td>0.13</td> </tr> <tr> <td>32G</td> <td>48</td> <td>0.15</td> </tr> <tr> <td>32H</td> <td>50</td> <td>0.15</td> </tr> </tbody> </table>  <p>0.7 Al</p>	No.	H	Weight kg/m	32A	15	0.09	32B	20	0.10	32C	25	0.10	32C+	27	0.10	32D	30	0.11	32E	35	0.12	32F	40	0.13	32G	48	0.15	32H	50	0.15	<p>No. 35 T-LIST WITH TONGUE</p>  <p>1.0 Al 0.28 kg/m</p>	
No.	H	Weight kg/m																														
32A	15	0.09																														
32B	20	0.10																														
32C	25	0.10																														
32C+	27	0.10																														
32D	30	0.11																														
32E	35	0.12																														
32F	40	0.13																														
32G	48	0.15																														
32H	50	0.15																														

Latest information: www.lautex.com

All products are subject to modifications without prior notice

LAUTEX LISTS

Length= 3000

Page 2/3

No. 51 Z-LIST

No.	H	Weight kg/m
51A	15	0.42
51B	20	0.44
51C	25	0.48
51D	30	0.54
51E	35	0.58
51F	40	0.62
51G	48	0.68
51H	50	0.70

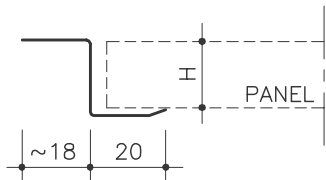

1.0 Steel (Weights in the table)
1.5 Al Can be bent

No. 53 U-INSERT LIST

No.	H	Weight kg/m
53A	15	0.10
53B	20	0.11
53C	25	0.12
53C+	27	0.12
53D	30	0.13
53E	35	0.14
53F	40	0.15

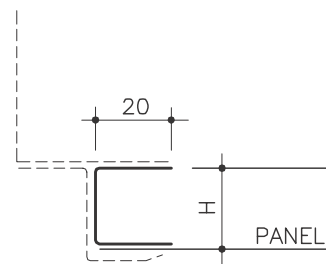

0.7 Al

No. 84 U-END LIST

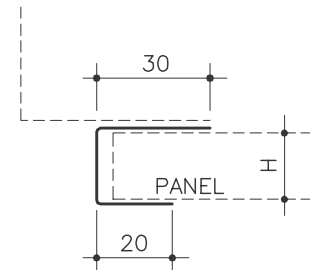

No.	H	Weight kg/m
84A	15	0.17
84B	20	0.18
84C	25	0.20
84C+	27	0.20
84D	30	0.21
84E	35	0.23
84F	40	0.24

1.0 Al

No. 52 HAT LIST

No.	H	Weight kg/m
52A	15	0.23
52B	20	0.26
52C	25	0.29
52D	30	0.31
52E	35	0.34
52F	40	0.37
52G	48	0.39
52H	50	0.40

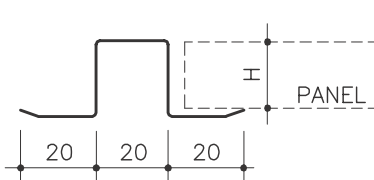

1.0 Al

No. 83 L-LIST 29x50

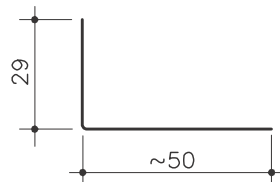

1.5 Al 0.32 kg/m
1.0 steel 0.62 kg/m

No. 85 L-END LIST

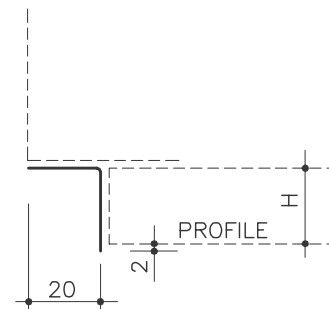

No.	H	Weight kg/m
85A	15	0.10
85B	20	0.11
85C	25	0.12
85D	30	0.14
85E	35	0.15
85F	40	0.16
85F+	42	0.17
85G	45	0.18
85H	50	0.19

1.0 Al

LAUTEX LISTS

Length= 3000

Page 3/3

No. 107 Z-INSERT LIST

No.	H	Weight kg/m
107A	15	0.16
107B	20	0.18
107C	25	0.19
107C+	27	0.19
107D	30	0.20
107E	35	0.22
107F	40	0.23

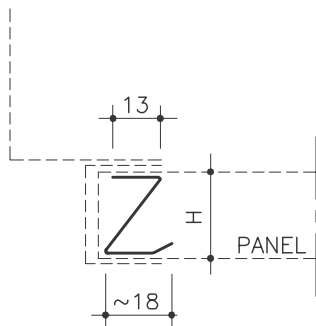

0.4 Steel

CURVED LISTS - DIRECTION OF RADIUS

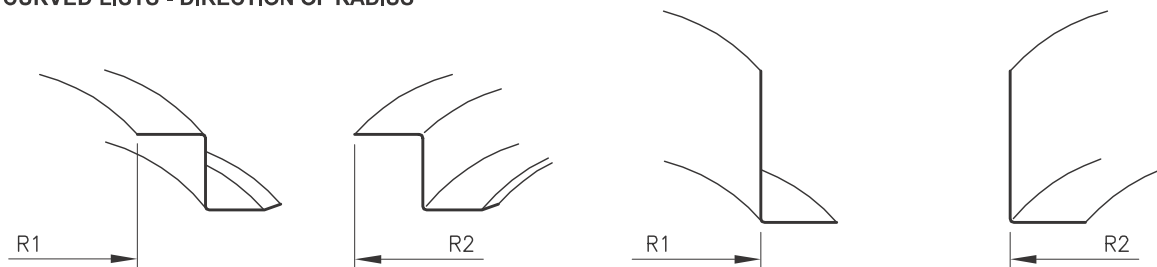

Latest information: www.lautex.com

All products are subject to modifications without prior notice